

LAR-0653 QT 60ShA

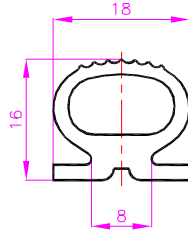

QT 65ShA  
LAR-1359 QT 50ShA

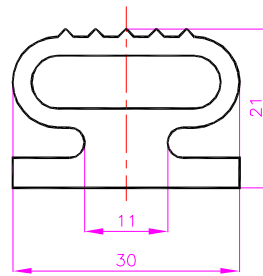

LAR-1398 QT 60ShA

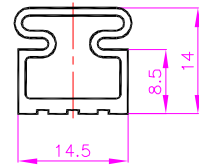

LAR-1433 QT 60ShA

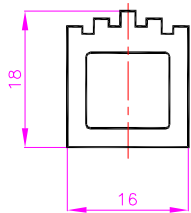

LAR-1445 QT 50ShA

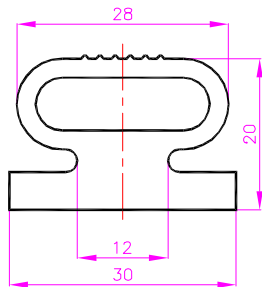

LAR-1864 QT 45ShA

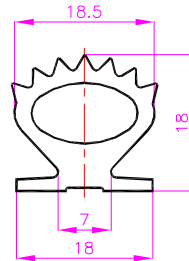

LAR-1897 QT 60ShA

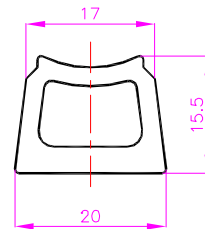

LAR-1910 QT 50ShA

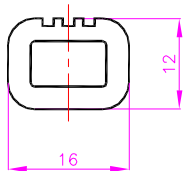

QT 65ShA  
LAR-2344 QT 55ShA

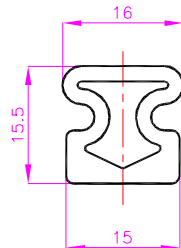

LAR-2363 QT 60ShA

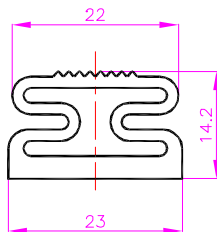

LAR-2579 QT 60ShA

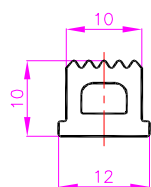

PT 55ShA  
QT 60ShA  
LAR-2168 QT 55ShA

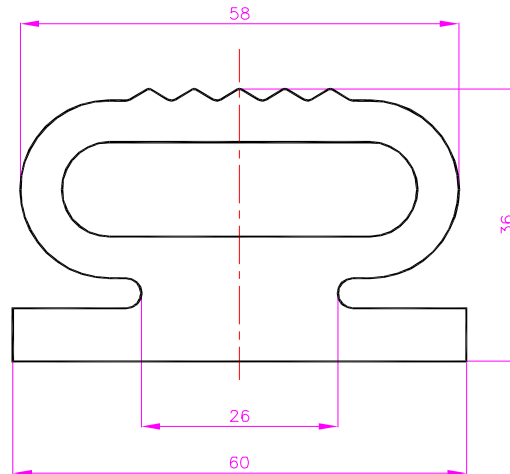

QT 70ShA  
LAR-2456 QT 60ShA

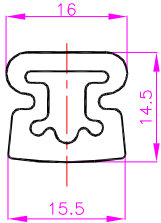

LAR-2620 QT 60ShA

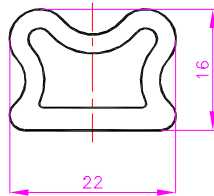

LAR-3299 QT 60ShA

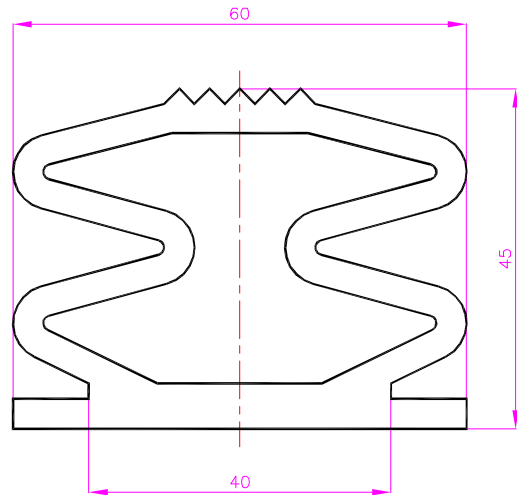

LAR-2649 QT 60ShA

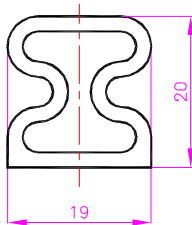

LAR-2805 QT 60ShA

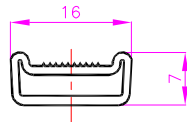

LAR-3345 QT 60ShA

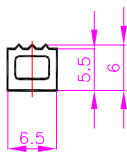

LAR-3352 QT 60ShA

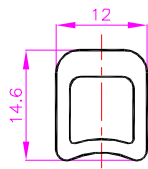

LAR-3543 QT 60ShA

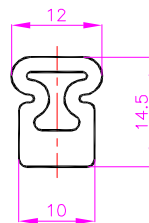

LAR-3623 QT 60ShA

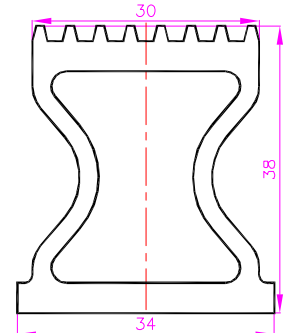

LAR-3655 TR-01 70ShA

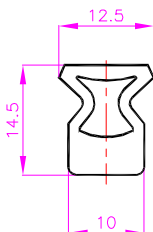

LAR-3674 QT 60ShA

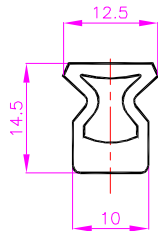

LAR-3684 QT 60ShA

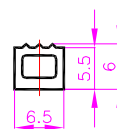

LAR-3721 TR-01 70ShA

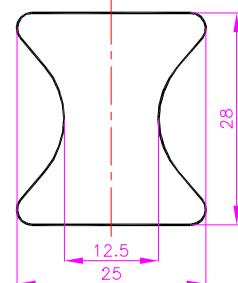

LAR-3741/2 QT 70ShA

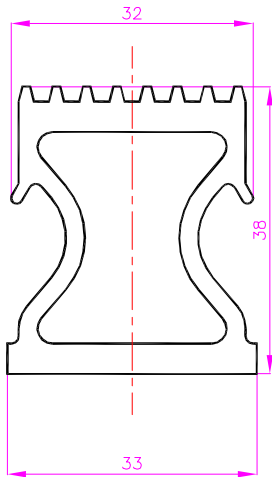

LAR-3741 TR-01 70ShA

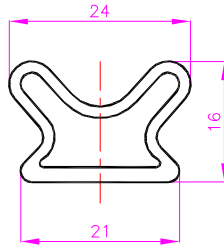

LAR-3521 QT 60ShA

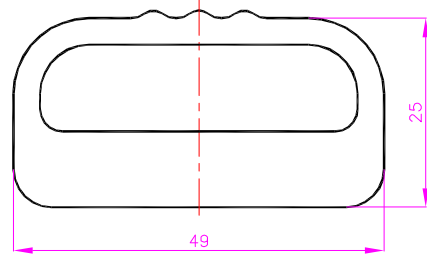

LAR-3003 QT 65ShA  
QT 60ShA

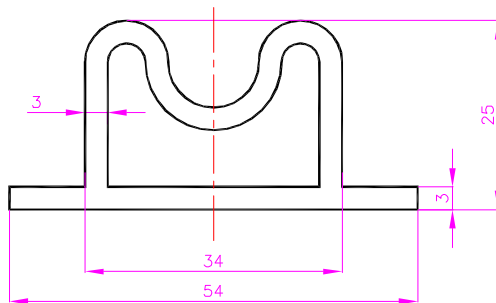

LAR-4125 QT 60ShA

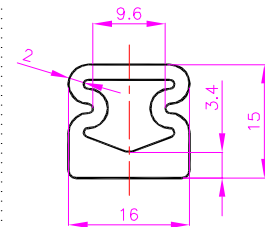

LAR-4163 QT 60ShA

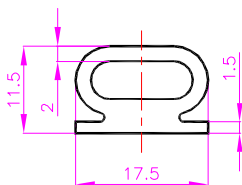

LAR-4293 BfR 60ShA

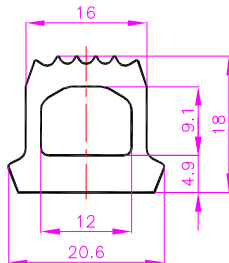

LAR-4342 PTQ 60ShA

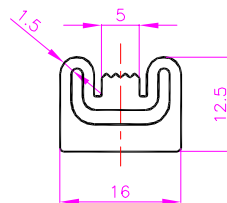

LAR-4360 BfR 60ShA

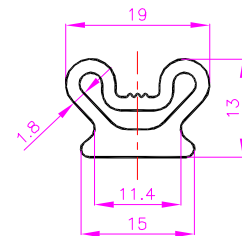

LAR-4363 TR 70ShA

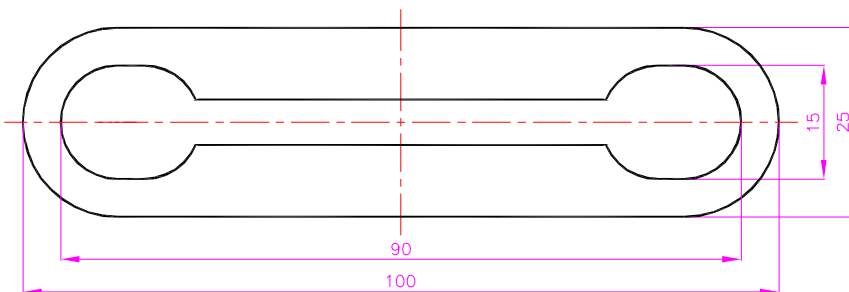

LAR-4499 OL 40ShA

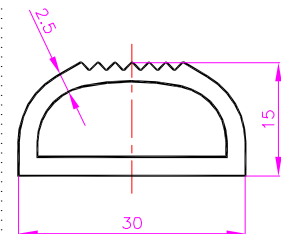

LAR-4396 QT 60ShA

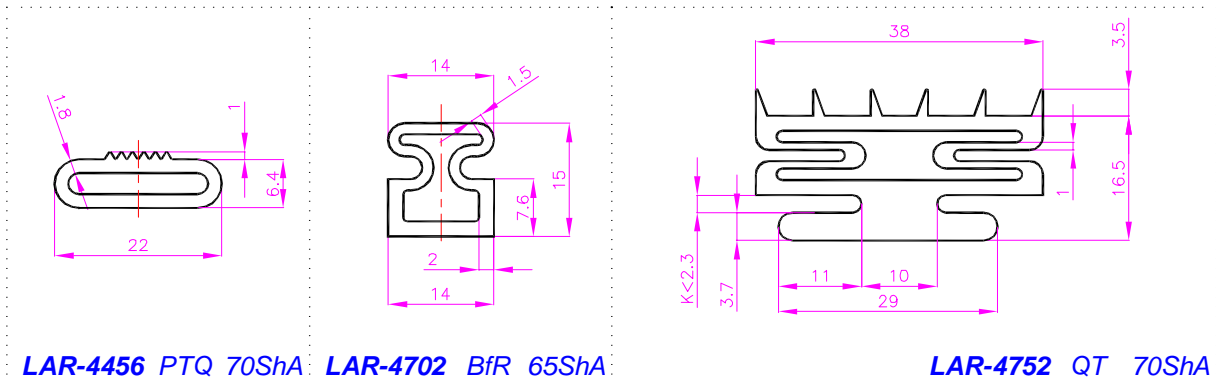

**LAR-4456 PTQ 70ShA** **LAR-4702 BfR 65ShA** **LAR-4752 QT 70ShA**

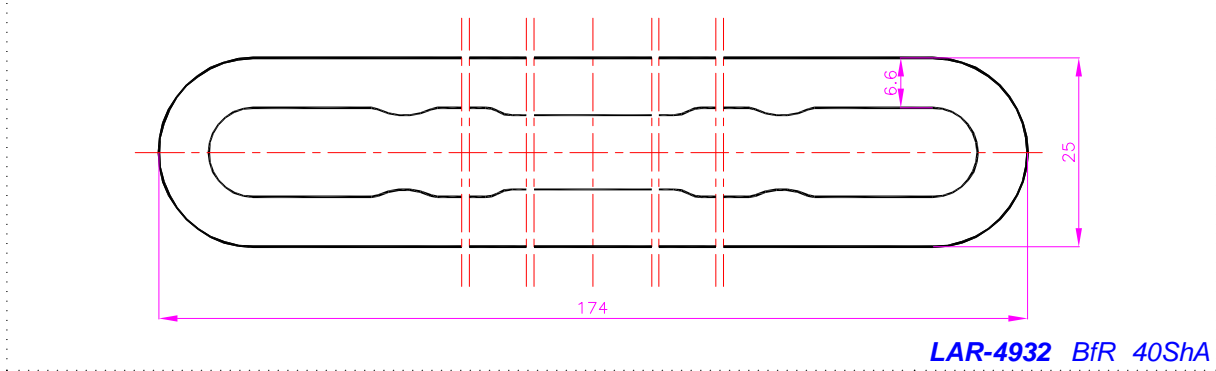

**LAR-4932 BfR 40ShA**

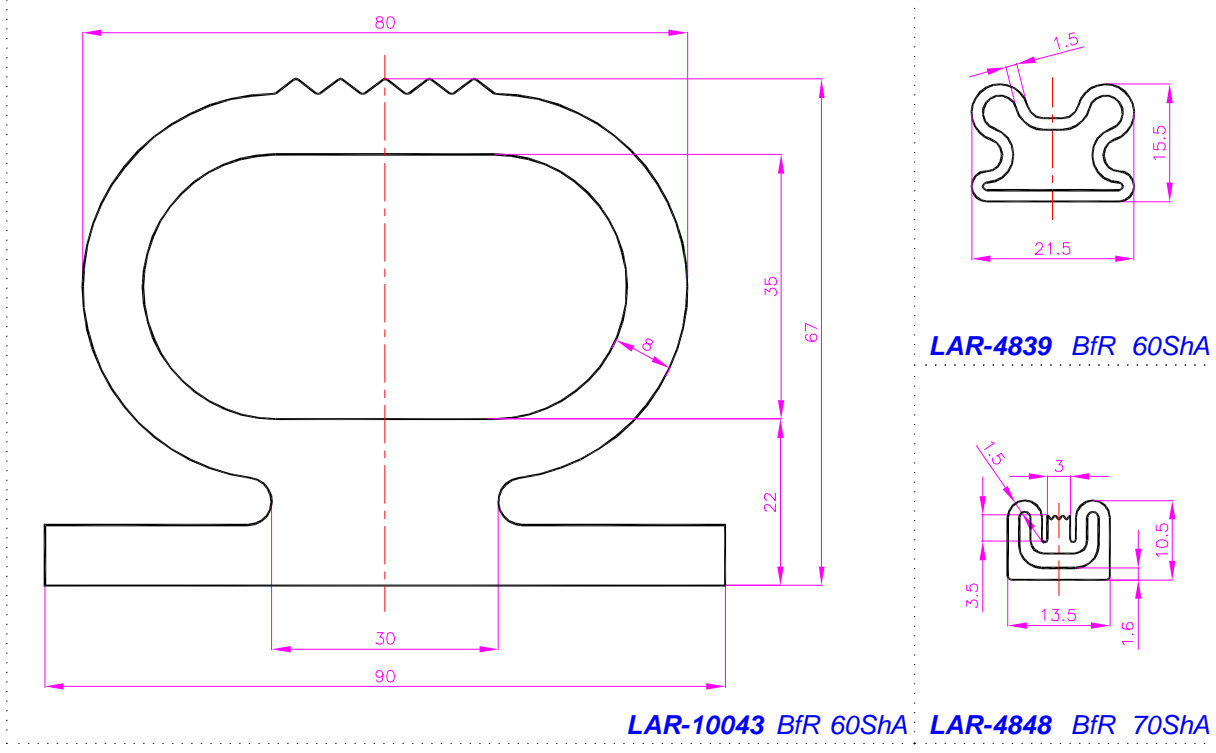

**LAR-4839 BfR 60ShA**

**LAR-10043 BfR 60ShA** **LAR-4848 BfR 70ShA**

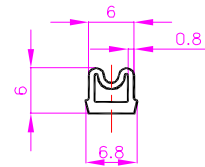
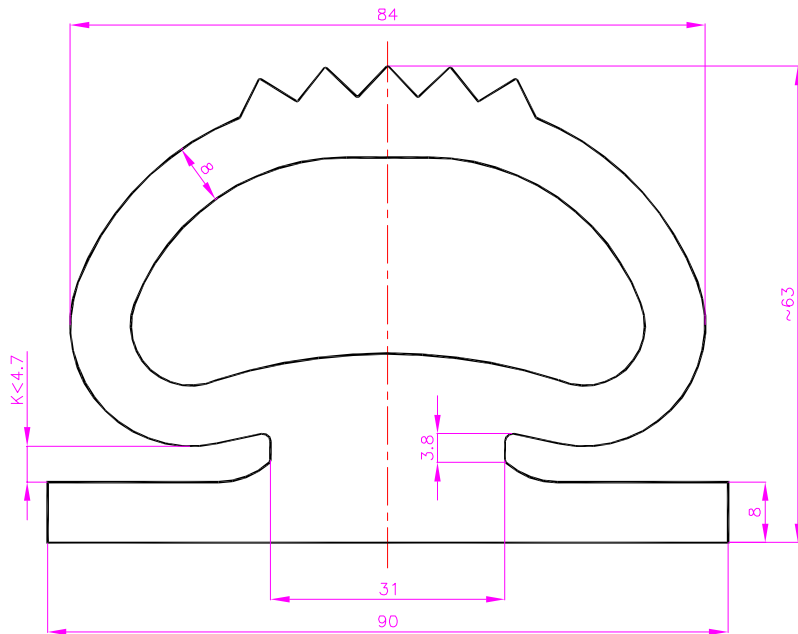

LAR-4044 HQT 45ShA

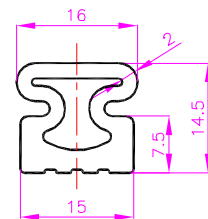

LAR-10138 BfR 60ShA LAR-4676 BfR 65ShA

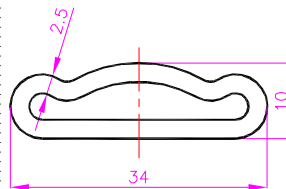
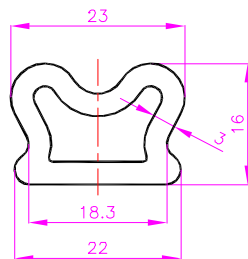
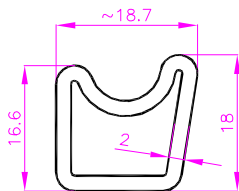

LAR-4733 QT 60ShA LAR-4947 BfR 55ShA LAR-10025 BfR 55ShA